

**095000-6367 Injector Orifice Plate 29# Technical File**

SKU1: G1Z11000000029

SKU2: G1F12950402900

SKU3: G1L32950402900

SKU4: G1N12950402900

SKU5: G1Z172950402900



## 095000-6370 Injector Orifice Plate 29# Technical File

### Content

1. 095000-6370 Injector Orifice Plate Introduction .....	2
1.1. 095000-6370 Injector Orifice Plate 29# Basic Information .....	2
1.2. 095000-6370 Injector Orifice Plate 29# Common Part Number .....	2
1.3. 095000-6370 Injector Orifice Plate 29# Specifications and Dimensions .....	2
1.4. 095000-6370 Injector Orifice Plate 29# Quality Control .....	2
1.5. 095000-6370 Injector Orifice Plate 29# Customized Service .....	3
1.6. 095000-6370 Injector Orifice Plate 29# Packing List .....	4
1.7. 095000-6370 Injector Orifice Plate 29# Lettering Detail's Display .....	5
1.8. 095000-6370 Injector Orifice Plate 29# Thickness Measurement Tool's Introduction .....	9
1.9. 095000-6370 Injector Orifice Plate 29# Thickness Measurement Methods .....	10
1.10. 095000-6370 Injector Orifice Plate 29# Warranty Instructions .....	12
1.11. 095000-6370 Injector Orifice Plate 29# Manufacturer .....	13
2. 095000-6370 Injector Orifice Plate 29# Technical Support .....	13
2.1. 095000-6370 Injector Orifice Plate 29# Inspection and Semi Ball Inspection .....	13
2.2. 095000-6370 Injector Orifice Plate 29# Level of Damage Inspection .....	15
2.3. 095000-6370 Injector Orifice Plate 29# Installation Steps .....	18
2.4. 095000-6370 Injector Orifice Plate 29# Technical Support Obtaining Methods .....	32
3. 095000-6370 Injector Orifice Plate 29# Purchase and Delivery .....	32
3.1. 095000-6370 Injector Orifice Plate 29# Purchase Payment Methods .....	32
3.2. 095000-6370 Injector Orifice Plate 29# Main Sales Markets .....	32
3.3. 095000-6370 Injector Orifice Plate 29# Declaration Requirements .....	33
3.4. 095000-6370 Injector Orifice Plate 29# Shipping Ways .....	33
3.5. 095000-6370 Injector Orifice Plate 29# Lead time .....	33
3.6. 095000-6370 Injector Orifice Plate 29# Logistics Time for Destination Out of China's Areas .....	33
3.7. 095000-6370 Injector Orifice Plate 29# Packing .....	33
4. 095000-6370 Injector Orifice Plate 29# Storage Standard .....	34
5. Company Information .....	35
5.1. Company Introduction .....	36
5.2. Sales-men's Contact Information .....	36
6. Copyright Statement .....	36

## 095000-6370 Injector Orifice Plate 29# Technical File

### 1. 095000-6370 Injector Orifice Plate 29# Introduction

#### 1.1. 095000-6370 Injector Orifice Plate 29# Basic Information

Title	China made new 095000-6370 fuel Injector Orifice Plate's 29#
SKU1	G1Z11000000029
SKU2	G1F12950402900
SKU3	G1L32950402900
SKU4	G1N12950402900
SKU5	G1Z172950402900

#### 1.2. 095000-6370 Injector Orifice Plate 29# Common Part Number

##### (1) 095000-6370 Injector Orifice Plate 29# Application to Car Model Information

Injector Part Number	Car Model	OE Number	OE Number	OE Number	OE Number
095000-6370	ISUZU FORWARD 6HK1	SX001-09236	SX001- 14334	8- 97609789- 6	

##### (2) 095000-6370 Injector Orifice Plate 29# Part Number Common Writing

29#, 19, 295040-6680, 2950406680, 2950406680

#### 1.3. 095000-6370 Injector Orifice Plate 29# Specifications and Dimensions

Injector Orifice Plate's Size: 2cm\*2 cm \*1 cm

Injector Orifice Plate's Box Size: 7cm \*7 cm \*2 cm

Injector Orifice Plate's Package Size: 8 cm \* 8cm

Injector Orifice Plate's Net Weight: 0.015kg

Injector Orifice Plate's Gross Weight: 0.03kg

Injector Orifice Plate's Quality: China Made Brand New

MOQ: 4 Pieces

#### 1.4. 095000-6370 Injector Orifice Plate 29# Quality Control

##### (1) 095000-6370 Injector Orifice Plate 29# Testing

All 095000-6370 injector orifice plate 29# parts are subjected to A-hole flow test, Z-hole flow test, precision test, high temperature test, low temperature test, pressure test, leakage test, durability test, and various working condition tests.

##### (2) 095000-6370 Injector Orifice Plate 29# Inspection





The factory inspection of 095000-6370 injector orifice plate 29# is undergone three inspections - full inspection, random inspection, and batch inspection. Different brands of test benches are used to test 095000-6370 injector orifice plate 29# for a total of no less than three times for factory inspection, and 095000-6370 injector orifice plate 29# installation testing environment are progressed in dust-free workshop.



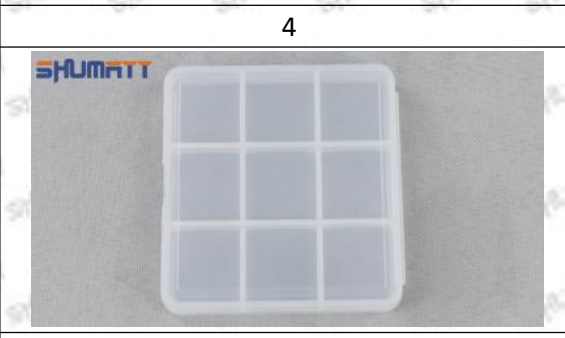

**1.5. 095000-6370 Injector Orifice Plate 29# Customized Service**

**(1) 095000-6370 Injector Orifice Plate 29# Customized Service Range:**

Meet the OEM manufacturers customized demands of orifice plate's lettering, orifice plate's thickness, orifice plate's packing box, orifice plate's anti-rust bag and label etc.

**(2) 095000-6370 Injector Orifice Plate 29# Customized Items**

<b>No.</b>	1	2
<b>Image</b>		
<b>Name</b>	Injector Orifice Plate's Front Lettering	Injector Orifice Plate's Side Lettering
<b>Description</b>	Orifice plate part number: <b>29#</b>	/
<b>No.</b>	3	4
<b>Image</b>		
<b>Name</b>	Injector Orifice Plate's Thickness	9-Grid Plastic Box
<b>Description</b>	Injector orifice plate's thickness range: 4.02mm~4.108mm.	Prevent damage to the orifice plates during transportation
<b>No.</b>	5	6
<b>Image</b>		
<b>Name</b>	Neutral Injector Orifice Plate's Individual Box	Orifice Plate's 10pcs Packing Box
<b>Description</b>	Prevent damage to the orifice plates during transportation	Liwei orifice plate's 10PCS plastic box to prevent damage to the orifice plates during transportation
<b>No.</b>	7	8

<b>Image</b>		
<b>Name</b>	Injector Orifice Plate's Individual Box	Orifice Plate's 12pcs Packing Box
<b>Description</b>	Liwei orifice plate's individual box	Greenpower orifice plate's 12PCS plastic box to prevent damage to the orifice plates during transportation
<b>No.</b>	9	10
<b>Image</b>		
<b>Name</b>	Shumatt Orifice Plate's Box	Orifice Plate's VCI Anti-Rust Bag
<b>Description</b>	Shumatt orifice plate's plastic box to prevent damage to the orifice plates during transportation	9-grid orifice plate packaging box's blue VCI anti-rust bag, suitable for long-term storage of the orifice plate
<b>No.</b>	11	/
<b>Image</b>		/
<b>Name</b>	Shumatt Label	/
<b>Description</b>	/	/

**(3) 095000-6370 Injector Orifice Plate 29# Customized Service Requirements:**

Custom lettering of injector orifice plate are not less than 100 pieces.

Custom packing boxes of injector orifice plate are not less than 100 pieces.

The purchase of injector orifice plates are not less than 100 pieces.

When customized products involve the need of specific logo, the OEM manufacturer has to provide trademark authorization and the sample of logo image file.

**▲ Once the customized 095000-6370 injector orifice plate 29# is sold, it cannot be returned or exchanged if there is no quality problems.**

**1.6.095000-6370 Injector Orifice Plate 29# Packing List**

**(1) 095000-6370 Injector Orifice Plate 29# Spare Parts List**

No.	1	2
Image		
Name	Injector Orifice Plate	9-Grid Box
Description	Orifice plate part number: <b>29#</b>	9-grid plastic box to prevent damage to the orifice plates during transportation. (10pcs or 12pcs packing box is optional)
No.	3	4
Image		
Name	Injector Orifice Plate's Individual Box	Neutral VCI Anti - Rust Bag
Description	To prevent damage to the orifice plates during transportation. (liwei individual box is optional)	To prevent the orifice plates from rusting.

▲ Minors are forbidden to use 095000-6370 injector orifice plate 29# and orifice plate's box to avoid personal injury.

▲ The orifice plate's plastic box is recyclable and can be reused.

▲ VCI anti-rust bag is non-degradable, please dispose them properly after using.

### 1.7. 095000-6370 Injector Orifice Plate 29# Lettering Detail's Display

#### (1) Orifice Plate's Lettering



Pic No. 1

1: Oil Port Number	2: Grade Recognition Number	3: Manufacture Number	/
--------------------	-----------------------------	-----------------------	---



**(2) Orifice Plate's Structure**



Pic No. 2



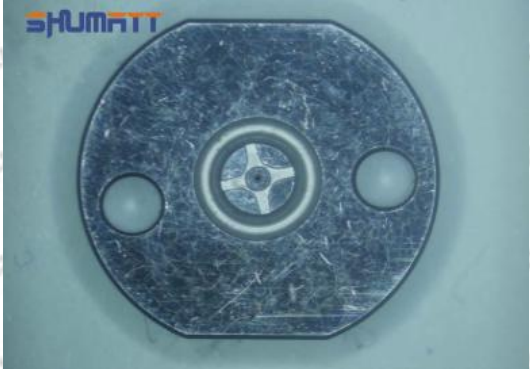
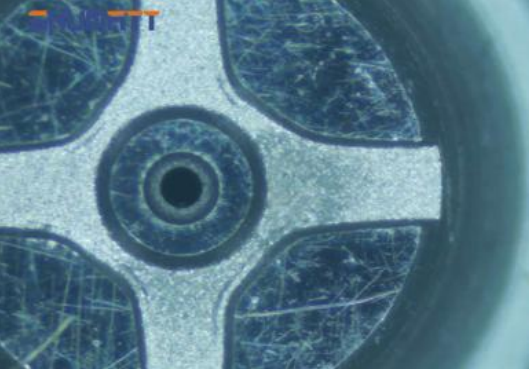
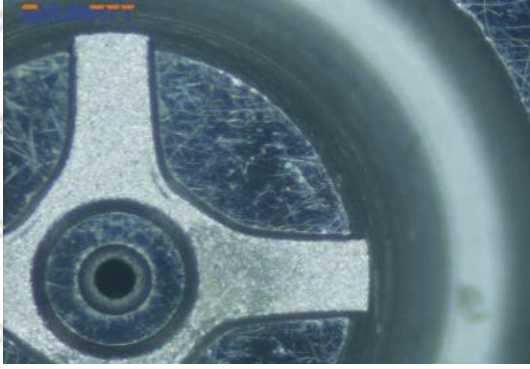

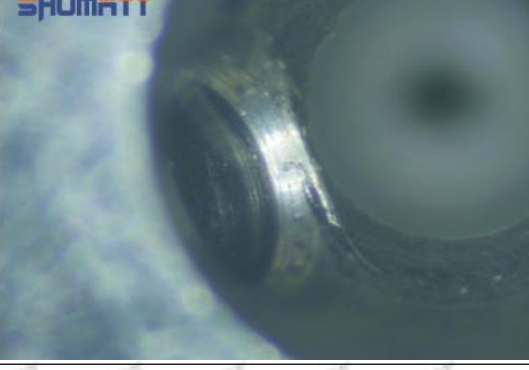
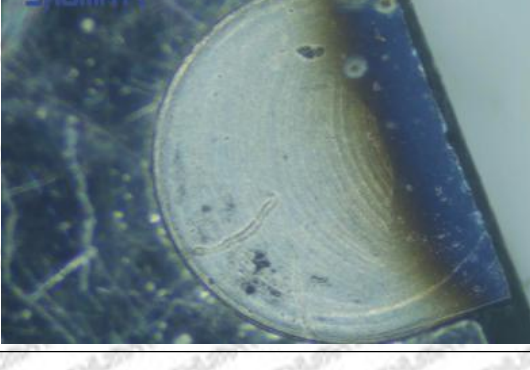
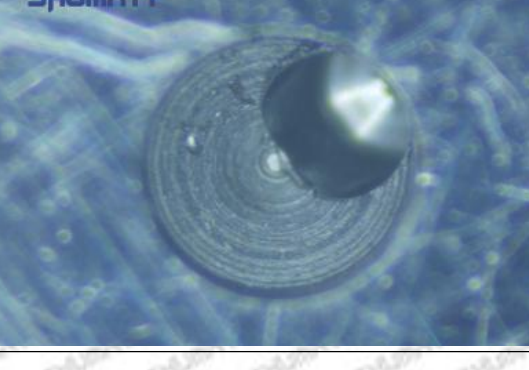
4: Oil Inlet	5: Stabilizing Pin	6: Front of Oil Back-flow Hole	7: Mark Location
--------------	--------------------	--------------------------------	------------------

**(3) 095000-6370 Injector Orifice Plate 9# Liwei Orifice Plate's Multi-angle Pictures**

	
<p>Back of Orifice Plate</p>	<p>Middle Oil Back-flow Hole</p>
	
<p>Side of Middle Oil Back-flow Hole</p>	<p>Side of Middle Oil Back-flow Hole</p>
	
<p>Oil Port Number</p>	<p>Front of Oil Outlet</p>
	
<p>Mark Location</p>	<p>Oil Inlet</p>

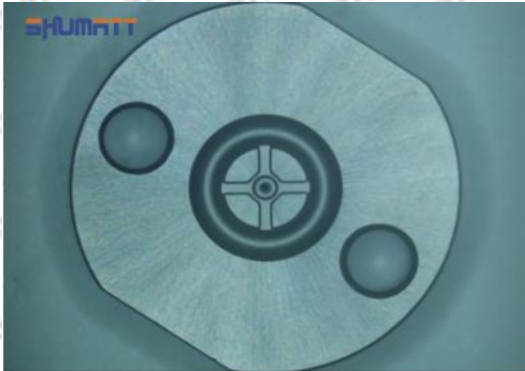
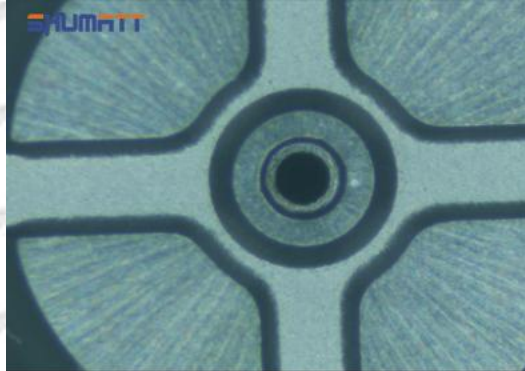

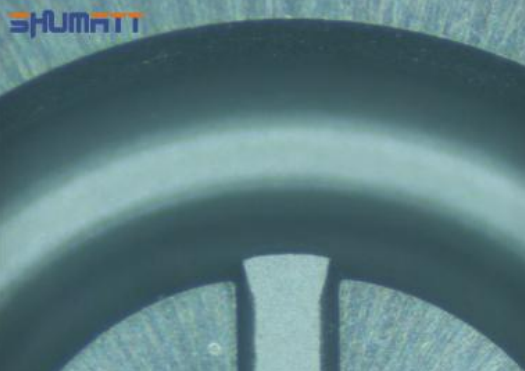
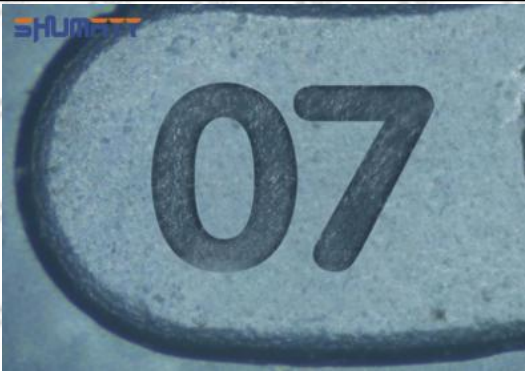
(4) 095000-6370 Injector Orifice Plate 29# Neutral Orifice Plate's Multi-angle Pictures

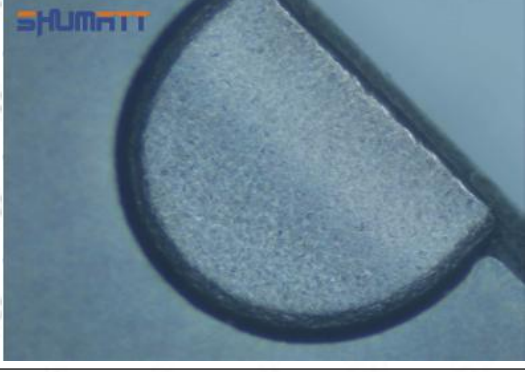
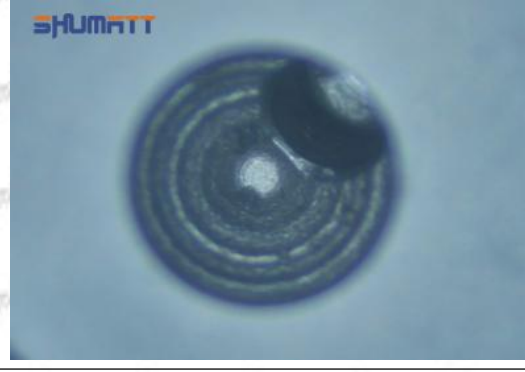
	
<p>Back of Orifice Plate</p>	<p>Middle Oil Back-flow Hole</p>
	
<p>Side of Middle Oil Back-flow Hole</p>	<p>Side of Middle Oil Back-flow Hole</p>
	
<p>Oil Port Number</p>	<p>Front of Oil Outlet</p>
	
<p>Mark Location</p>	<p>Oil Inlet</p>

**1.8.095000-6370 Injector Orifice Plate 29# Thickness Measurement Tool's Introduction**

**(1) Electronic Vernier Caliper**

● **Technical Parameters**

1. Made of stainless steel.
2. Resolution: 0.01mm/0.001.
3. Can set on zero at any location.

● **Parts' Name**

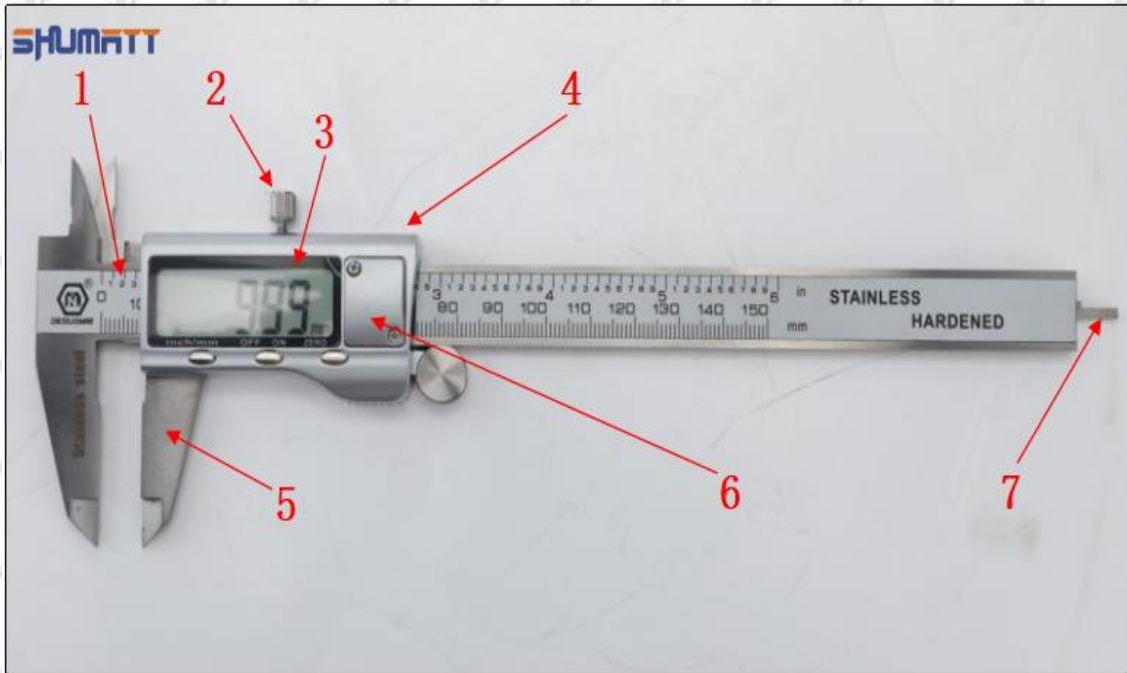

Pic No.1

1: Caliper Body	2: Caliper Frame Fastening Screw	3: LCD	4: Data Output Port
5: Data Output Port	6: Battery Cover	7: Depth Bar	/

**(2) Electronic Digital Display Micrometer**

● **Technical Parameters**

1. Range: 0-25mm,25-50mm,50-75mm,75-100mm
2. Resolution: 0.001mm
3. Power: Voltage 1.5V button battery
4. Working Temperature: 0~+40℃
5. Storage Temperature: -20~+70℃
6. Environment Humidity: ≤80%

● **Parts' Name**



Pic No.2

1: Micro-tube	2:Ratchet Force Measuring Device	3: Data Output Port	4: Display Screen	5: mm Function Key
6: ON/OFF ZERO Function Key	/	/	/	/

### 1.9.095000-6370 Injector Orifice Plate 29# Thickness Measurement Methods

#### (1) Electronic Vernier Caliper

1. Preparation: Clean all surfaces of the caliper with a dry soft cloth, please make sure there is a battery in the caliper before using it;
2. Press the OFF/ON button on the vernier caliper to turn on the caliper;
3. When you turn on the vernier caliper, sometimes there is data on the screen. This is because the caliper is not fully closed. You can roll the caliper with fingers to close it, and then press the ZERO button to return to zero;
4. Put the orifice plate into the caliper and press it tightly by rolling the button;
5. After tightening, use the other hand to tighten the upper button of the caliper to prevent looseness from affecting the accuracy of the reading. Last read the data.



Pic No.1

**▲ Notice:** When using the electronic vernier caliper, be sure to return on zero port, otherwise there will be a large error in the measurement results!

## (2) Electronic Digital Display Micrometer

1. Preparation: Clean all surfaces of the caliper with a dry soft cloth, please make sure there is a battery in the caliper before using it;

2. Use of ON/OFF ZERO function key:

In the "off" state, short press the ON/OFF ZERO function key to start up, the micrometer is in the metric reading (shown on the right of the display "mm") mode and display the set value. If there is no set value, the initial value is displayed as "0".

In the power-on state, press and hold (more than 2 seconds) the ON/OFF ZERO function key to shut down.

In the power-on state, short press the ON/OFF ZERO function key, and the display returns to the set value or the initial value "0".

3. Use of "mm" function keys:

In the power-on state, short press the "mm" function key to realize the conversion of metric ("mm" is displayed on the right side of the display) and inch ("in" is displayed on the right side of the display) display mode.

In the power-on state, press and hold (more than 2 seconds) the "mm" function key to enter the setting value mode;

### Setting of set value:

Long press (more than 2 seconds) the "mm" key to make the first character flash, and short press the ON/OFF ZERO key to select any number from 0 to 9;

Short press the "mm" key, and jump to the next character to flash, use the same method to select all the characters, press and hold (more than 2 seconds) the "mm" key to complete the preset value, then the character will no longer flash;

Once the setting value is set, it will last until the battery is removed or the battery is exhausted.

4. Data Transfer Method:

Open the data output port cover, insert the data acquisition line (need to be purchased separately) into the outer micrometer, and connect the other end to the company's data acquisition adapter (need to be purchased separately) or connect to the computer.



Pic No.2

**1.10. 095000-6370 Injector Orifice Plate 29# Warranty Instructions**

**(1) . 095000-6370 Injector Orifice Plate 29# Warranty Conditions and Instructions**

It is necessary to provide the pictures, videos of 095000-6370 injector orifice plate 29# when the injector orifice plate is abnormal during use or the test report of 095000-6370 injector orifice plate 29# inspection equipment as evidence to feedback to the salesman.

Abnormal conditions are properly explained such as : 1.Black smoke, 2. Engine shake, 3. Difficulty starting the engine, 4. Engine noise, 5. Oil leakage etc.

The above conditions may also be affected by incorrect installation of the fuel injector. If it is confirmed that it is product problem after being tested by our company, the injector orifice plate is within the scope of warranty.

**(2) . 095000-6370 Injector Orifice Plate 29# Warranty Coverage**

After customer receives the 095000-6370 injector orifice plate 29# within 15 days , customer can choose to replace it if there is a performance failure and the product has no appearance damage;

If the 095000-6370 injector orifice plate 29# has performance problems during the warranty period (3 months), and it is confirmed to be product' s problems after being tested, you can contact our salesmen to replace the same model or a reworked product with the same performance for free;

If the injector orifice plate is confirmed to be fault-free, it can only be repaired and it will be returned as original way.

**(3) . 095000-6370 Injector Orifice Plate 29# Out of Warranty Coverage**

The 095000-6370 injector orifice plate 29# is artificially damaged due to assembly errors during the process of assembling.

The warranty period has expired.

095000-6370 injector orifice plate 29# failure caused by high temperature, high pressure, humidity, rain and snow, saline-alkali land, earthquake, and used in abnormal environment.

095000-6370 injector orifice plate 29# damage caused by man-made reasons (throwing, strong magnetic field magnetization, set fire).

095000-6370 injector orifice plate 29# failure or injector damage caused by non-injector orifice plate's design, technology, manufacturing, quality and other issues.

1095000-6370 injector orifice plate 29# failure due to system pressure exceeding system approved pressure.

095000-6370 injector orifice plate 29# failure caused by impurities (water, lead, aluminum powder, iron powder, sulfide) in the system fuel exceeding the standard requirements.

095000-6370 injector orifice plate 29# failure caused by not installing according to the tightening torque specified in the vehicle engine maintenance manual (the tightening torque is too large or too small).

095000-6370 injector orifice plate 29# failure caused by not following the installation angle specified in the vehicle engine maintenance manual.

095000-6370 injector orifice plate 29# failure caused by not following the cleaning requirements specified in the vehicle engine maintenance manual.

095000-6370 injector orifice plate 29# failure caused by failure to replace consumable parts as specified in the vehicle engine maintenance manual.

**1.11.095000-6370 Injector Orifice Plate 29# Manufacturer**

**Manufacturer:** Shenzhen Shumatt Technology Co., Ltd

**2. 095000-6370 Injector Orifice Plate 29# Technical Support**

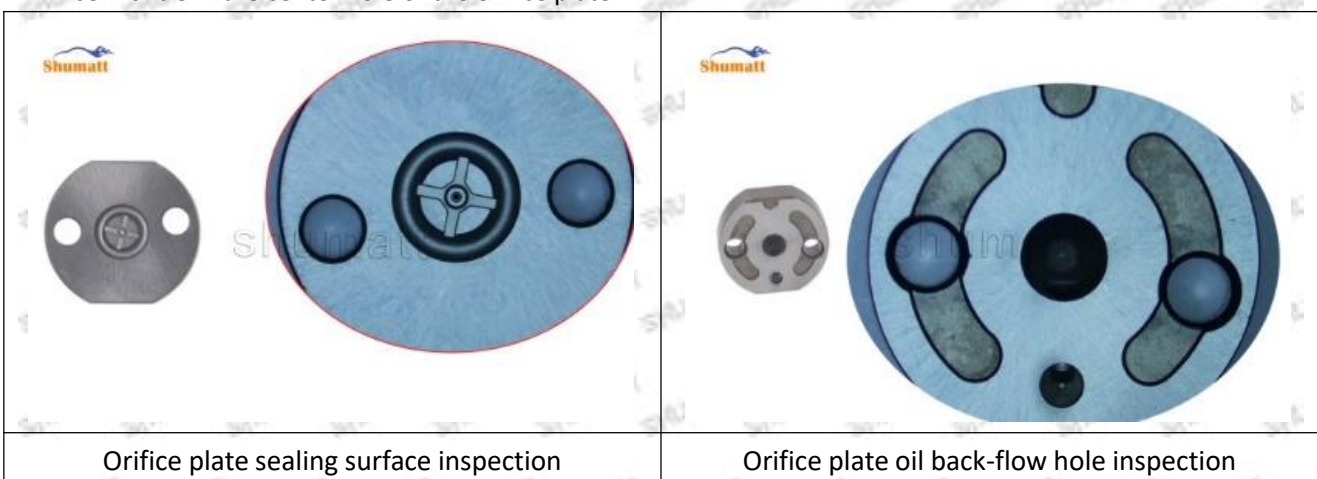

**2.1.095000-6370 Injector Orifice Plate 29# Inspection and Semi Ball Inspection**

- (1) Magnify 500 times under the microscope to check whether there is indentation on the sealing surface and the oil outlet hole of the orifice plate, check whether there is wear, scratch, damage, rust, depression, semicircle in the center hole of the orifice plate.





<p>Orifice plate center deviation inspection</p>	<p>There is indentation on the side, the orifice plate needs to be replaced</p>
<p>There is indentation in the middle oil back-flow hole, the orifice plate needs to be replaced</p>	<p>The middle oil back-flow hole is semicircular, the orifice plate needs to be replaced</p>

- ▲ The blockage of the oil back-flow hole will cause small volume of the oil return, and the oil will not be injected.
  - ▲ When oil back-flow hole becomes larger, it causes the semi ball to be not tightly sealed, which causes the fuel injection pressure cannot be established, then the fuel injector cannot work normally.
  - ▲ The wear on orifice plate's surface causes gap to the semi ball, which leads to large volume of oil return, in serious cases, the pressure can not be built up and nozzle will spray oil directly.
  - ▲ The blockage of the oil inlet hole (side hole) will cause small amount of oil return, the blockage of oil inlet side hole will cause the injector cannot build a pressure chamber, as a result, the injector cannot work normally.
- (2) Magnified 500 times under the microscope, check the plane position of the semi ball, if there is any scratch, it is recommended to replace it.

	
<p>Semi ball's surface inspection</p>	<p>Semi ball's surface inspection</p>

**2.2.095000-6370 Injector Orifice Plate 29# Level of Damage Inspection**

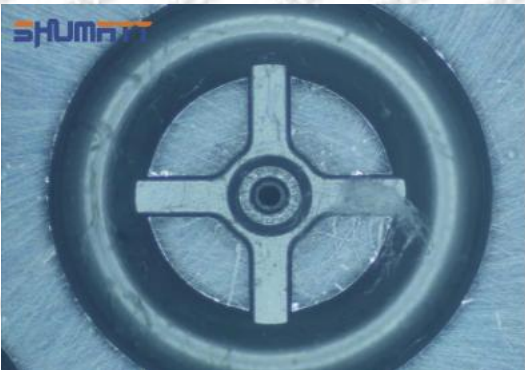
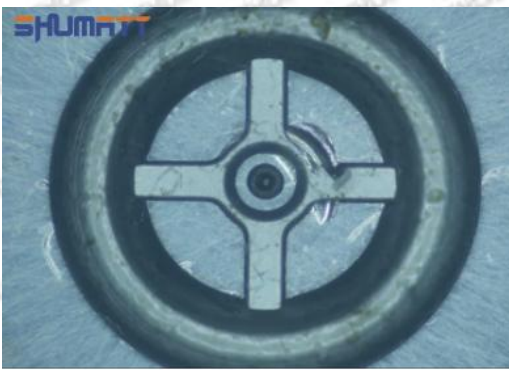
**(1) Slight Damaged**

	
<p>Wear marks on edge</p>	<p>The misalignment of the semi ball causes damage to the orifice plate when installing it</p>
	<p>/</p>
<p>The wear of the middle oil back-flow hole causes gap between semi ball and orifice plate, and causes the orifice plate to be washed out by high-pressure oil</p>	<p>/</p>

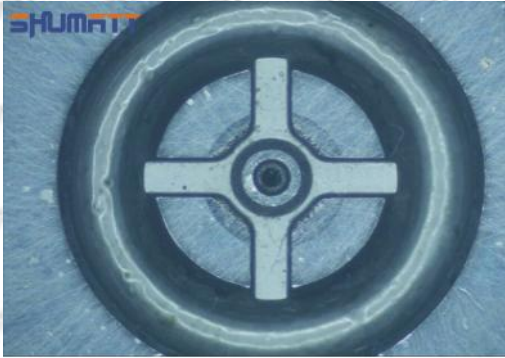
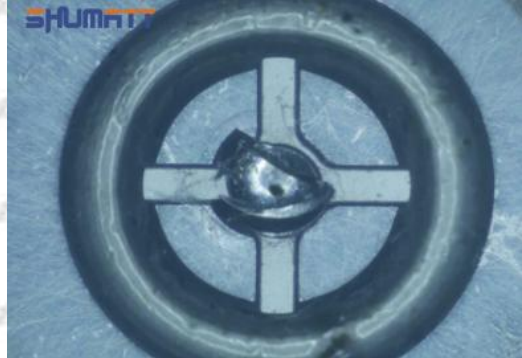
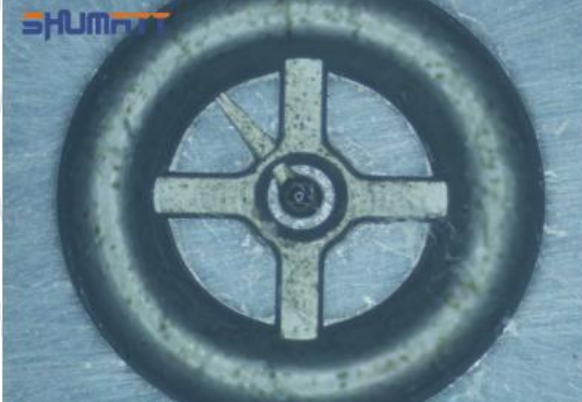

(2) Moderate Damaged

	
<p>Wear marks on edge</p>	<p>The misalignment of the semi ball causes damage to the orifice plate when installing it</p>
	<p>/</p>
<p>The wear of the middle oil back-flow hole causes gap between semi ball and orifice plate, and causes the orifice plate to be washed out by high-pressure oil</p>	<p>/</p>

(3) Highly Damaged

	
<p>Obvious Wear marks on edge</p>	<p>The misalignment of the semi ball causes damage to the orifice plate when installing it</p>

<p>The wear of the middle oil back-flow hole causes gap between semi ball and orifice plate, and causes the orifice plate to be washed out by high-pressure oil</p>	

(4) More Pictures of Orifice Plate's Damage Details

<p>The misalignment of the semi ball</p>	<p>Marks of the misalignment of the semi ball</p>
<p>The indentation of the misalignment of the semi ball</p>	<p>Washout marks caused by the presence of impurities in the fuel</p>

Washout marks caused by the presence of impurities in the fuel	The front of oil outlet
Water in fuel causes to rusting	Water in fuel causes to rusting

## (5) Impact Classification According to The Degree of Damage to The Orifice Plate

Damage Type	Severe Damaged	General Damaged	Slight Damaged
Classification	A	B	C
Impact on Overall Performance	Cause the fuel injector to not work properly, damage the vehicle engine or cause serious loss	Cause the injector cannot work normally, the vehicle cannot start normally, and the vehicle stop working	Cause Excessive oil return of injector and the vehicle engine shaking
Impact on Features	Affect the normal operation of the engine	Affect the normal operation of the injector	Affect the fuel injection volume of the injector
Impact on Safety of Use	Cause serious damage to the engine and cause safety accident	Cause serious damage to the injector and may cause safety accident	Cause serious damage to the injectors and the vehicle stop working

**2.3.095000-6370 Injector Orifice Plate 29# Installation Steps**

- Before install 095000-6370 injector orifice plate 29#, clean it in an ultrasonic cleaning machine for 3-5 minutes so that to make the dirt, anti-rust oil oxide, paraffin base, naphthenic base, intermediate base, salt, lead naphthenate, zinc naphthenate, sodium petroleum sulfonate, barium petroleum sulfonate, calcium petroleum sulfonate, tallow diamine trioleate and rosin amine shedding fall off.

- (2) Use compressed air to clean up the cleaning fluid attached to the surface of the cleaned orifice plate to meet the use standard.
- (3) When installing the orifice plate, install it according to the oil hole A on the orifice plate, and match A, B, C on the orifice plate with A, B, C on the injector house. See as Pic No. 1



Pic No. 1

- (4) Put the orifice plate into the injector with the stabilizing pin inserted into the stabilizing hole, see as Pic No. 2

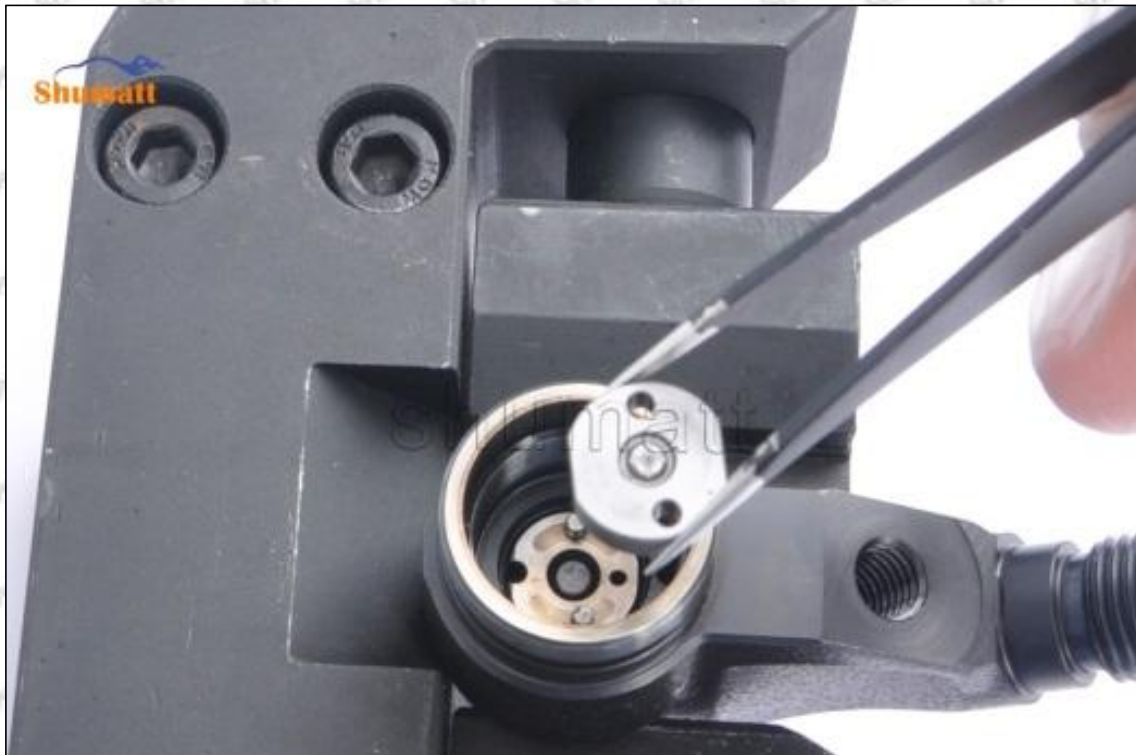

Pic No. 2

(5) Place the buffer lift measurement tool and dial gauge in the measuring tool (CRT220) at zero port for buffer stroke measurement, see as Pic No. 3



Pic No. 3

Buffer Stroke: When the solenoid valve is powered off, the spring force of the opened solenoid valve transfers to the center of the armature plate and drives the armature plate to go down. When the valve ball contacts the oil return hole in the center of the orifice plate, the oil back-flow hole is closed. However, the armature plate has to run down a certain distance under the inertia, and this distance is called the buffer stroke.

The normal range of the buffer stroke is 20-40 (um) microns.

(6) The measurement of buffer lift is in the normal range, within 20-40 (um) microns, see as Pic No. 4



Pic No. 4

▲ Notice: The buffer stroke is the distance between the plane A of the semi ball to the plane B of the lock nut. If it is lower than 20-40 (um) microns, grind the B plane to 20-40 (um) microns. If it is higher than 20-40 (um) microns, check worn parts and replace it.

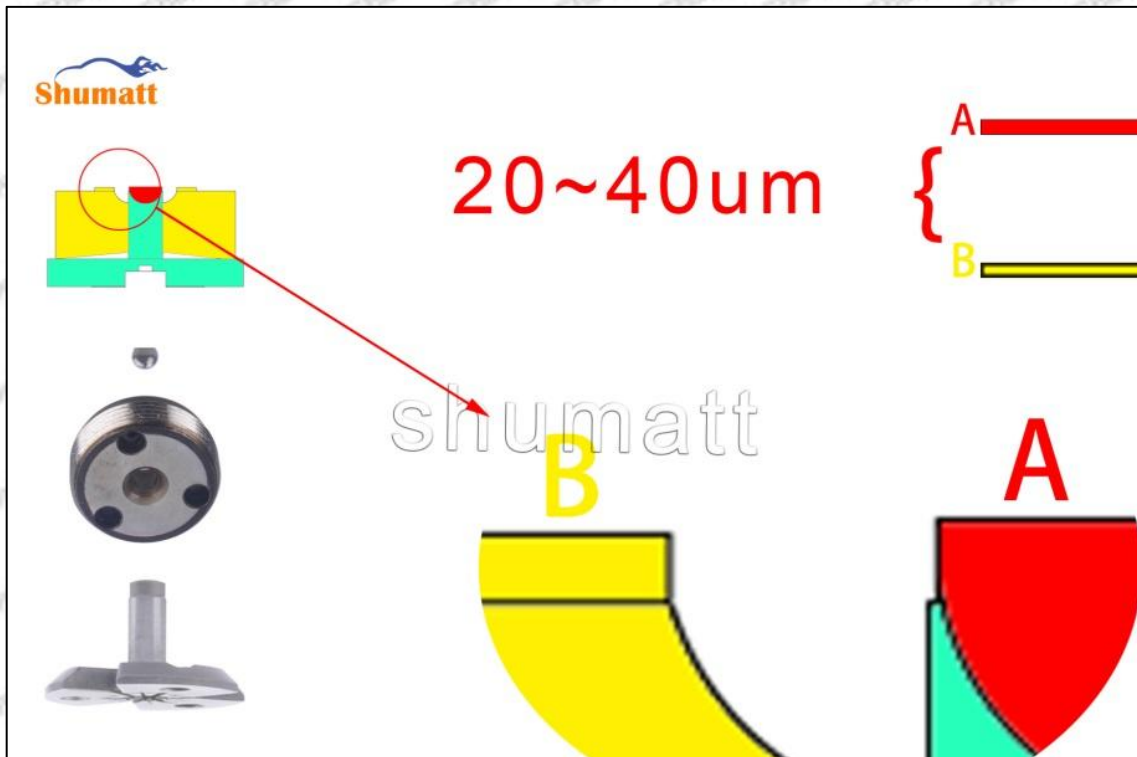

Pic No. 5

(7) Install the air clearance lift measuring tool and dial gauge in the measuring tool (CRT220) and place it at zero port for air clearance measurement, see as Pic No. 6



Pic No. 6

▲ Air clearance measurement normal range value is 45-50 (um) microns.

(8) The measurement of air clearance is in the normal range, within 45-50 (um) microns, see as Pic No. 7



Pic No. 7

▲ Notice: The air gap is the distance between plane A and plane B at the top of the armature, if the gap is not within 45-50 (um) microns, please replace it.



Pic No. 8

(9) Install lock nut, see as Pic No. 9



Pic No. 9

(10) Install the (CRT230) 3-jaw tool inside the CRT029 on the lock nut, see as Pic No.10



Pic No.10



(11) Rotate (CRT084) clockwise with a torque wrench to tighten the lock nut to 70-75Nm, see as Pic No.11



Pic No.11

(12) When installing the semi ball, it should be noted that the plane of the semi ball cannot be reversed, otherwise it may cause damage to the orifice plate, see as Pic No.12

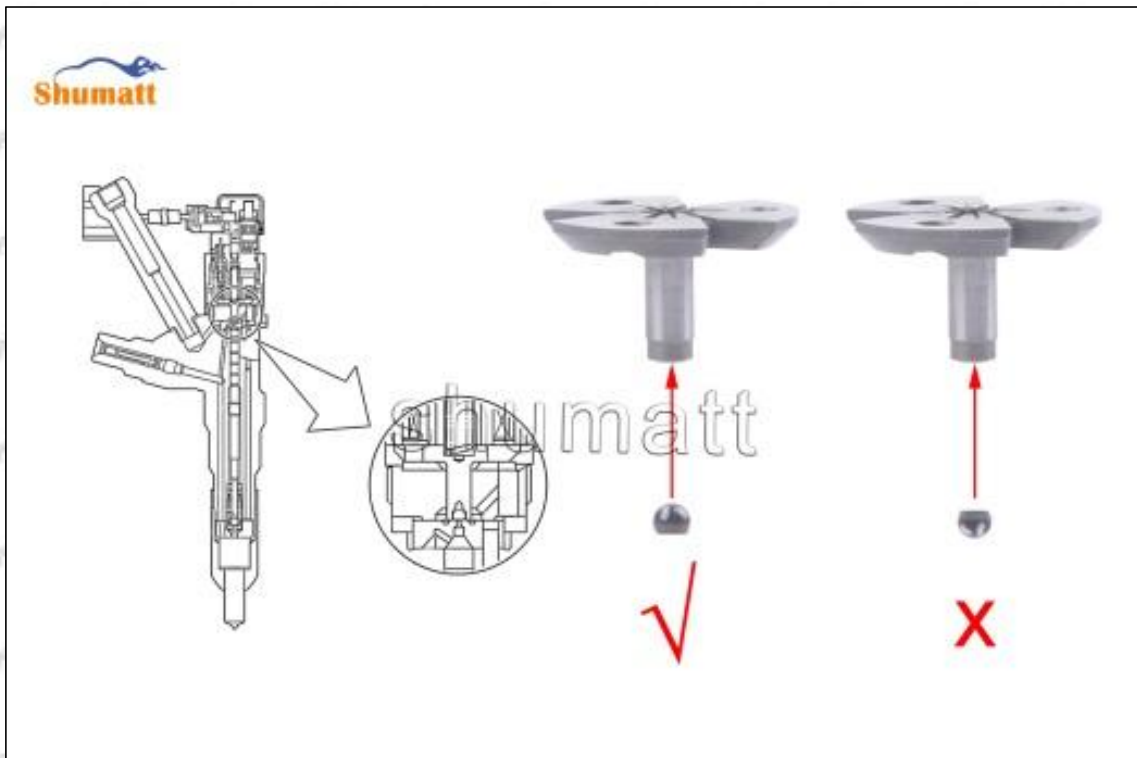

Pic No.12

(13) place the semi ball on the armature, Pic No.13



Pic No.13

(14) Put the armature with semi ball into the lock nut (**Make sure that the armature buffer stroke and armature air clearance lift are within the normal range**), see as Pic No.14



Pic No.14

(15) Measure the thickness of the armature lift adjustment gasket, see as Pic No.15



Pic No.15

(16) Put the armature lift adjustment gasket into the solenoid valve, see as Pic No.16



Pic No.16

(17) Install the armature stroke measuring tool and dial gauge in the measuring tool (CRT220) and place it on zero to measure armature travel, see as Pic No.17



Pic No.17

The stroke of the armature also controls the final lifting position of the semi ball. The greater the stroke of the armature is lifted, the longer it will take for the return oil to rush in the orifice plate, which will cause the orifice plate to fail in a short time and the injector to fail to work normally. However, the stroke of the armature should not be too small, otherwise it will cause insufficient fuel injection, resulting in problems such as reduced engine power and engine shaking.

(18) The measurement of the solenoid valve's lift of the armature is 3.413, see as Pic No.18



Pic No.18

(19) Measure the armature travel of the injector housing end again, see as Pic No.19



Pic No.19

(20) Subtract the two data measured in step 17 and step 18 to get the normal range value of armature stroke between 60-65um. If the value is too large or too small, replace the armature lift according to the measurement results and adjust the thickness of the shim to make the armature stroke range reach the normal range, see as Pic No.20



Pic No.20

(21) Put the solenoid valve spring adjustment shim into the solenoid valve, see as Pic No.21

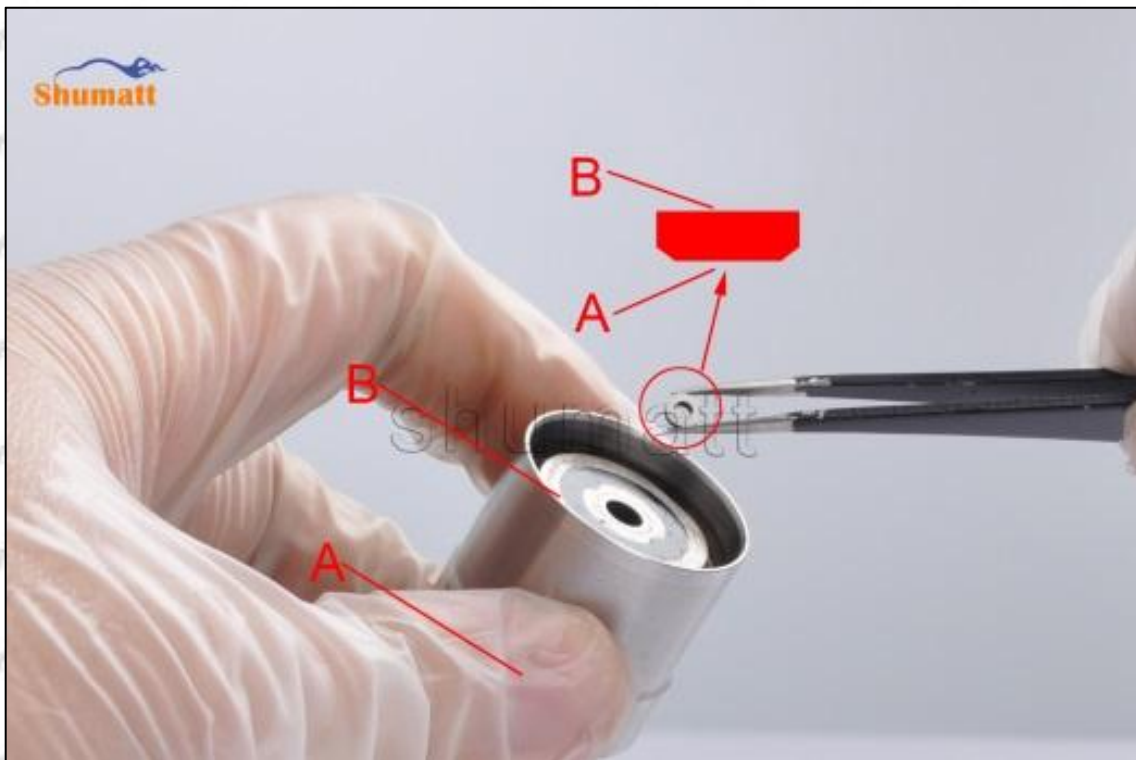

Pic No.21

(22) Put the solenoid valve spring into the solenoid valve, see as Pic No.22



Pic No.22

(23) Install the solenoid valve sealing ring on the fuel injector, see as Pic No.23



Pic No.23

(24) Install the solenoid valve on the fuel injector, If the solenoid valve is not replaced, install it according to

the red mark. If there is a replacement solenoid valve, install it according to the standard angle which checked on Truck book Parts EPC APP, see as Pic No.24



Pic No.24

(25) Tighten the solenoid valve clockwise with a torque wrench (CRT084) to 25-35Nm, see as Pic No.25



Pic No.25

(a) Leak Test



Test Result:

1. The oil return is not sealed: there is no seal between the orifice plate and the semi ball.

May Lead To:

Oil return volume increased, oil leakage when the nozzle is in an open state, pressure cannot be established, and the injector fail to work, etc.

Solution:

Check or replace the orifice plate and Semi ball.

(b) VL Test

Test Result:

1. The maximum fuel injection volume is too large;
2. The maximum fuel injection volume is too small.

May Lead To:

1. The maximum fuel injection volume too large will cause the exhaust gas smoke and the fuel consumption will be high;
2. The maximum fuel injection volume too small will cause the engine powerlessness and delayed acceleration.

Solution:

1. When the maximum fuel injection volume is too large, make the armature stroke adjustment gasket or the solenoid valve spring adjustment gasket thin, and fine-tune the nozzle lift adjustment gasket;
2. When the maximum fuel injection volume is too small, make the armature stroke adjustment gasket or the solenoid valve spring adjustment gasket thick, and fine-tune the nozzle lift adjustment gasket.

### 2.4.095000-6370 Injector Orifice Plate 29# Technical Support Obtaining Methods

- (1) 095000-6370 Injector Orifice Plate 29# Technical File, visit <http://shumatt.com> to get the technical file.
- (2) **Injector Technical Videos**

**Facebook:** Visit <https://www.facebook.com/hison.li> to get the technical videos, constantly follow can get more information.

**YouTube:** [https://www.youtube.com/channel/UCByvYBx7VjV\\_mAfxh\\_Hu-aw](https://www.youtube.com/channel/UCByvYBx7VjV_mAfxh_Hu-aw) to get the technical videos, constantly follow can get more information.

**Shumatt:** Visit <http://shumatt.com> to get the technical videos.

- (3) Injector Information Query Software

TruckBook Parts EPC APP, Android/Apple App Store download and install, visit <http://shumatt.com> to get the download and installation tutorial

- (4) Search The fuel injector test data through TruckBook Parts EPC APP.

### 3.095000-6370 Injector Orifice Plate 29# Purchase and Delivery

#### 3.1.095000-6370 Injector Orifice Plate 29# Purchase Payment Methods

**Payment methods:** T/T, PayPal, Alipay, WeChat

**▲ Please contact our salesmen for specific payment information.**

#### 3.2.095000-6370 Injector Orifice Plate 29# Main Sales Markets

---

Injector orifice plate's main sales markets: Asia, Europe, North America, South America, Africa etc.

**3.3.095000-6370 Injector Orifice Plate 29# Declaration Requirements**

Shumatt can assist customers to provide the following documents for import customs clearance: contract, invoice, packing list, bill of lading, insurance policy, certificate of origin, etc.

**3.4.095000-6370 Injector Orifice Plate 29# Shipping Ways**

**Destination in China areas:** SF Express, Debon Express, the corresponding logistics company can be provided according to customer requirements in special cases.

**Destinations out of China's areas:** DHL, UPS, FedEx, TNT air, ocean or other shipping methods required by customers.

**3.5.095000-6370 Injector Orifice Plate 29# Lead time**

**Lead time:** Send out within 3 – 7 working days after receiving payment ( Except for special products and special cases ) .

**3.6.095000-6370 Injector Orifice Plate 29# Logistics Time for Destination Out of China's Areas**

**DHL Logistics Time :**

Country or Region of Departure	Hong Kong, China	Other Countries or Regions of Asia	Australia and New Zealand	Europe	America	Other Countries
China's Mainland	7 Days	7 Days	8 Days	8 Days	8-12 Days	7-10 Days

**UPS Logistics Time: Country or Region of Departure: China's Mainland**

Country of Destination	Estimated Arrival Time	Country of Destination	Estimated Arrival Time	Country of Destination	Estimated Arrival Time
Japan	3 Days	UK	5-7Days	Egypt	5-7 Days
Turkey	5-7 Days	Singapore	3 Days	Switzerland	5-7 Days
Bahrain	5-7 Days	Latvia	7-10 Days	New Zealand	7-10 Days
Sri Lanka	5-7 Days	Thailand	3 Days	Austria	5-7 Days
Romania	5-7 Days	Vietnam	3-5 Days	Estonia	5-7 Days
Malaysia	3-5 Days	Israel	5-7 Days	Mexico	7-10 Days
France	5-7 Days	America	5-7 Days	United Arab Emirates	5-7 Days
Italy	5-7 Days	Netherlands	5-7 Days	Bengal	7-10 Days
Lebanon	5-7 Days	Philippine	3-5 Days	Greece	7-10 Days
South Korea	3 Days	Spain	5-7 Days	Myanmar	5-7 Days
Canada	5-7 Days	Germany	5-7 Days	Saudi Arabia	7-10 Days
Portugal	5-7 Days	Australia	5-7 Days	South Africa	7-10 Days
Denmark	5-7 Days	Belgium	5-7 Days	Ukraine	7-10 Days
India	7-10 Days	Qatar	7-10 Days	Poland	5-7 Days
Indonesia	3-5 Days	Morocco	7-10 Days	Pakistan	7-10 Days
Kuwait	7-10 Days				

**▲ The logistics time is for reference only, subjects are according to the actual arrival.**

**3.7.095000-6370 Injector Orifice Plate 29# Packing**

**Domestic express packaging:** Usually wrapped in waterproof scotch tape, such as picture No.1.

**International express packaging :** Wrapped with waterproof yellow tape After wrapping the black protective film, such as picture No. 2.

**Pallet Shipping :** Use fumigation free and recycling trays that meet export requirements, and use white wrapping protective film to wrap and bind with cable ties for the outside, such as picture No. 3, also, the products can be packaged according to customers' requirements.

- ▲ The packing tray is made of plastic and can be recycled.
- ▲ Transparent tape, yellow tape, black wrapping protective film, white wrapping protective film are non-degradable materials, please dispose of them properly.
- ▲ Minors are prohibited from using transparent tape, yellow tape, black wrapping protective film, and white wrapping protective film to avoid personal injury.



Pic No. 1

**Domestic express packaging:**

Wrapped with Transparent tape

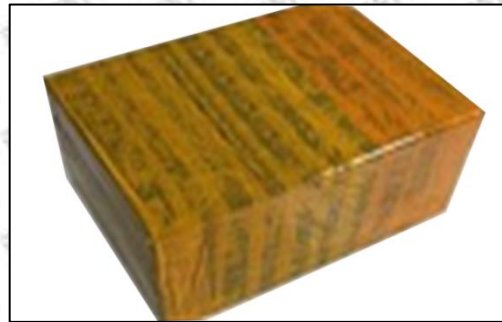

Pic No. 2

**International express packaging:**

Wrapped with yellow tape after wrapping black protective film



Pic No. 3

**Pallet Shipping:** Use pallet that meet export requirements, and use white wrapping protective film to wrap and bind with cable ties

#### 4.095000-6370 Injector Orifice Plate 29# Storage Standard

- (1) Choose a suitable storage place

The warehouse and cargo yard where 095000-6370 injector orifice plate 29# is stored should be kept clean and dry, and away from the factory buildings that generate harmful gases and dust; do not mix with acid, alkali, salt and other substances; the storage place should have a good drainage system; the cargo yard should be flattened with gravel or furnace ash etc. to enhance the water permeability of the surface layer to keep the reservoir area dry.

**(2) Strict requirements of warehousing**

Strict inspections should be carried out when 095000-6370 injector orifice plate 29# are put into storage, the surface cleaning work should be done well to remove water traces, oil stains, ash and other dirt, remove the rust and do anti-rust treatment in time. Packaged injectors must be protected from damage.

**(3) Keep the warehouse dry and preventing moisture**

The relative humidity is usually below 70% for 095000-6370 injector orifice plate 29# placed in the room, and the corrosion of the injector orifice plate is significantly reduced.

Injector orifice plates must be stored in the warehouse, and they are forbidden to store in the same warehouse with commodities with high water content.

**(4) Stack Properly**

After 095000-6370 injector orifice plate 29# is exposed to rain, the corrosion rate will increase significantly. The purpose of sealing is to isolate the injector orifice plate from rainwater and humid air, so the warehouse window should be checked in time to avoid rainwater entering the warehouse

If the 095000-6370 injector orifice plate 29# package is damaged, it should be repaired or replaced; when the package is damp, the packaging material should be dried; if the original anti-corrosion and oil applied at the factory is found to be damaged or dried up, it should be cleaned and re-applied oil in time.

- ▲ It is forbidden to leave 095000-6370 injector orifice plate 29# exposed in the air for a long time.
- ▲ It is forbidden to store acid, alkali, salt and other substances together with 095000-6370 injector orifice plate 29#.
- ▲ The unpacked 095000-6370 injector orifice plate 29# must be rust-proof during secondary storage.

**5. Company Information**



**5.1. Company Introduction**

**Chinese Name:** 深圳市舒马特科技有限公司

**English Name:** Shenzhen Shumatt Technology Co., Ltd

**Mob Phone/WeChat:** +86-13410541523

**HK Telephone:** +852-67653519

**Telephone:** +86-755-23215133

**Email:** ruby@shumatt.com

**Website:** www.shumatt.net

**Shenzhen Office:** 11-12, Floor 14, Building 13, Qinchengda Building, Exit A, Honglang North Subway Station, Bao'an District, Shenzhen, China's Mainland

**Shenzhen Office:** Room 428-430, Building B, Huafeng Zhigu Technology Industrial Park, Exit B, Fuyong Metro Station, Bao'an District, Shenzhen, China's Mainland

**Hong Kong Office:** Jianfa Street Industrial Zone, Tuen Mun, New Territories, Hong Kong, China

**After-sales Service Address:** Please contact our salesmen to obtain and provide the corresponding product maintenance reasons ( Reference : [1.10. 095000-6370 Injector Orifice Plate 29# Warranty Instructions](#) )

**5.2. Sales-men's Contact Information**

No.	Name	WeChat/WhatsApp	Email	Facebook	YouTube
1	Ruby	+86-13410541523	ruby@shumatt.com	Hison Li	Hison Li
2	Ivy	+86-18025299821	sales@shumatt.com	Ivy Shumatt	Shumatt IVY
3	Rebecca	+86-18025349821	sales01@shumatt.com	Rebecca SHUMATT	SHUMATT Rebecca
4	Janny	+86-18028749821	sales02@shumatt.com	Janny shumatt	Janny Shumatt
5	Sam	+86-13316859821	Sales8@shumatt.com	Shumatt Sam	Sam Shumatt
6	Natalie	+86- 18938945856	sales15@shumatt.com	Shumatt Natalie	Lin Natalie
7	Ada	+86-1342286353	sales5@shumatt.com	Shumatt Ada	Ada Shumatt
8	Hison Li	+86-18318811871	web@shumatt.com	Hison Li	Hison Li
9	Mecca	+86-18938948618	sales11@shumatt.com	Shumatt Mecca	Shumatt Mecca
10	Eric	+86 18319033618	sales3@shumatt.com		
11	Wayne ( Joaquín en español )	+86-13316959821	wayne@shumatt.com	Shumatt Wayne	Wayne Shumatt
12	Sylvia	+86 18312499884	sales6@shumatt.com		

Visit <http://shumatt.com> to obtain the latest information of salesmen

PS: Shumatt's sales-men's emails are all end with [@shumatt.com](mailto:@shumatt.com)

**6. Copyright Statement**

The copyright of any contents (including but not limited to parameters, data, text, charts, images, sounds or videos, etc.) provided in "095000-6370 Injector Orifice Plate 29# Technical File" belongs to Shenzhen Shumatt Technology Co., Ltd. Without the prior written permission of Shenzhen Shumatt Technology Co., Ltd., any users are not allowed to modify the contents in "095000-6370 Injector Orifice

Mob/WhatsApp: +86 13410541523

Email : [ruby@shumatt.com](mailto:ruby@shumatt.com)

© 2022 Shenzhen Shumatt Technology Co., Ltd

Tel: +8675523215133

Website : [www.shumatt.com](http://www.shumatt.com)

Plate 29# Technical File” in any way. At the same time, any conditions to spread, re-post, display the contents of “095000-6370 Injector Orifice Plate 29# Technical File” should indicate source from Shenzhen Shumatt Technology Co., Ltd., Any actions failure to follow above conditions to use “095000-6370 Injector Orifice Plate 29# Technical File” will violate the “Copyright Law of the People's Republic of China” and other laws and regulations and the provisions of relevant international conventions.